

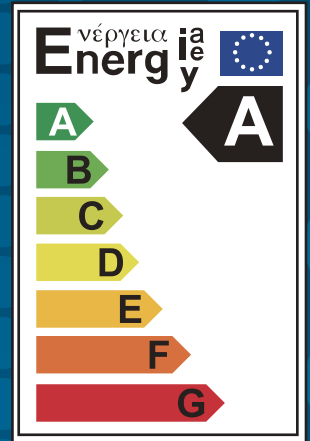

STAIRS

Pumping with confidence



HOT WATER CIRCULATOR PUMP



STAIRS INDUSTRIAL CO., LTD.

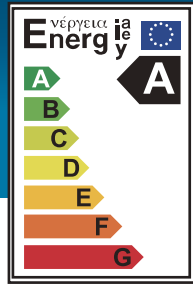

Description:

The AHW(S) series is a high energy-efficient variable speed circulator pump, this series pumps provide 8 different modes selection, such as Highest/Lowest proportional pressure, Highest/ Lowest constant pressure, Highest/ Medium/ Lowest constant speed, and Night version to replace existing fixed speed circulators in order to meet most circulation systems.

Features:

- High-efficiency motor design saving huge electricity
- Classical display panel makes the selection process easily
- Low noise operation
- Compact design easy to installation
- Optional Cast iron or stainless steel materials for wide range applications.



Applications:

- Specifically designed for single and double-heating systems.
- Ground source heat systems.
- Boiler/Solar water heating systems.
- Hot-water recirculation systems.
- Water circulation for cooling air-conditioning systems.
- High temperature liquids recycle systems.

Pumped Liquids:

Clean water, non-corrosive and non-abrasive liquids

Operating Conditions:

- Max. Ambient temperature: 40°C (105°F)
- Max. Liquid temperature: 110°C(230°F)
- Long time use temperature 80°C(176°F)

Model Code: AHW S 25-60 / 180

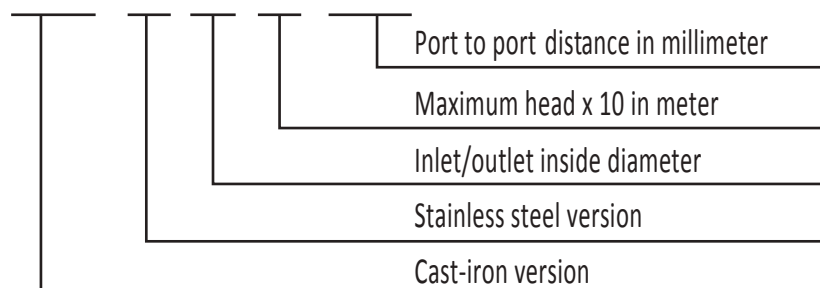

Control Panel:

Display definition	Explanation
light fields indicating the actual power watts	Actual power consumption in watts
Function III	Highest constant speed
Function II	Medium constant speed
Function I	Lowest constant speed
Function PP1	Lowest proportional pressure curve
Function PP2	Highest proportional pressure curve
Function CP1	Lowest constant pressure curve
Function CP2	Highest constant pressure curve
Night version	NIGHT SETBACK TURNDOWN

■ **Performance Curves:**

4M

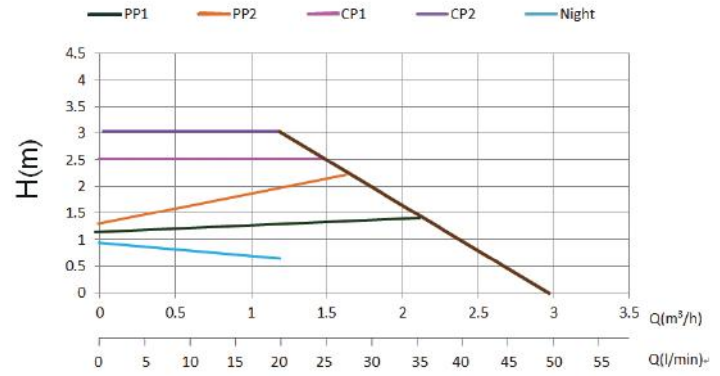
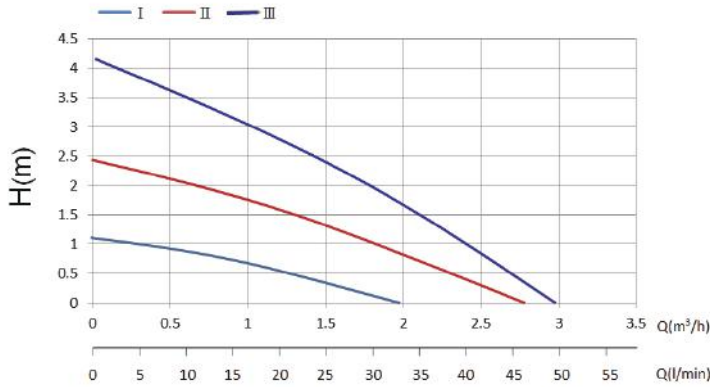

6M

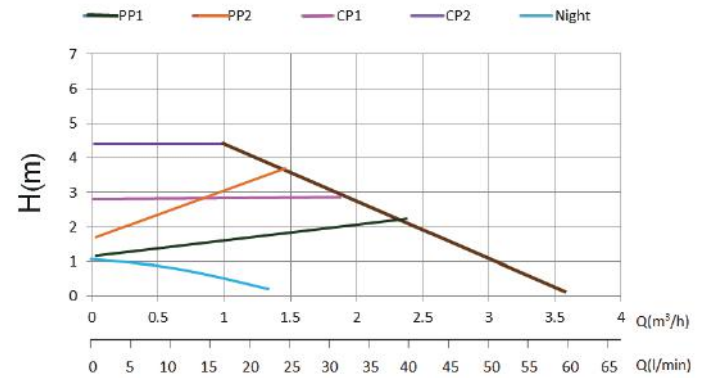
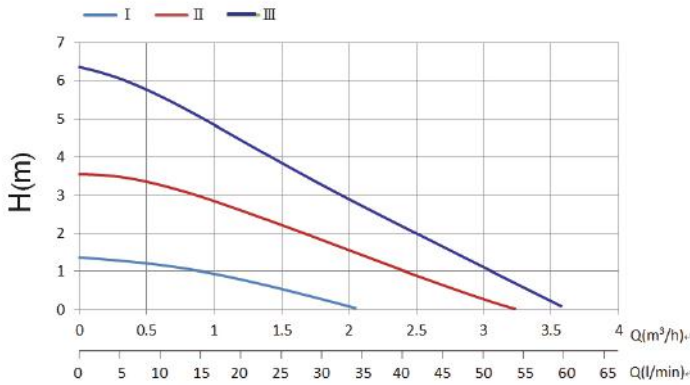

■ **Dimensions:**

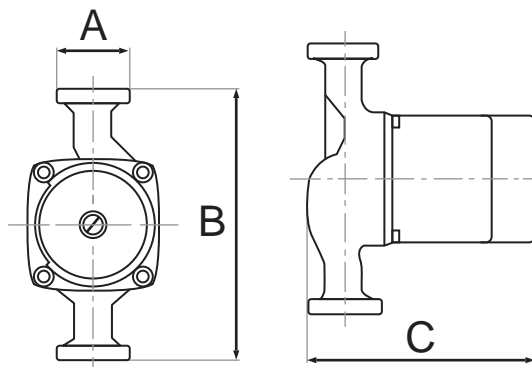

Dimensions(mm)		
A	B	C
1-1/2"	130 or 180	175

■ **Specifications:**

Model	Freq. (Hz)	Phase ϕ	Voltage	Max.Flow (L/min)	Max.Head (m)	Power (W)	Inlet/Outlet	Weight(kg)
AHW(S)-25-40-130	50/60	Single	220-240V	49	4	3-23	1-1/2	2.15
AHW(S)-25-40-180	50/60	Single	220-240V	49	4	3-23	1-1/2	2.45
AHW(S)-25-60-130	50/60	Single	220-240V	60	6	4-40	1-1/2	2.15
AHW(S)-25-60-180	50/60	Single	220-240V	60	6	4-40	1-1/2	2.45

S = stainless steel version



STAIRS

Pumping with confidence

Optional Accessories

Union Sets

Inlet/Outlet	Material
1-1/2 x 3/4	304 SS
1-1/2 x 1	304 SS

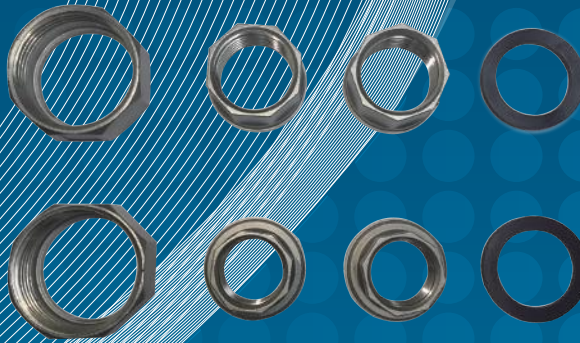

Note:
Specifications subject to change without notice.

No., 3-8, Sanchial Tsun, Lutsao Hsiang, Chiai Hsien, Taiwan.

Tel: +886 (0)53750488 Fax: +886(0)53752330

E-mail: stairs@stairs.com.tw

Website: www.stairs.com.tw